

PERGOLA

PERGOLA

019 Pergola Polycarbonate
Pergola Polycarbonate

022 Pergola Toile
Pergola Shade Cloth

025 Pergola Bioclimatique
Pergola Bioclimatic

PERGOLA POLYCARBONATE | PERGOLA POLYCARBONATE

SUNDAY

Caractéristiques | Characteristics:

- | | |
|--|---|
| <ul style="list-style-type: none"> - Poteau et faitière 120x64mm - Gouttière 93x141mm - Chevron 80x45mm - Aluminium thermolaqué Qualicoat / Qualimarine / Qualanod - Polycarbonate opale 16mm traité anti UV avec obturateur poly, adhésif microperforé - Platine de fixation au sol - Vis de fixation fournies | <ul style="list-style-type: none"> - Posts and beams 120x64mm - Rain gutter 93x141mm - Rafters 80x45mm - Powder coated aluminum Qualicoat / Qualimarine / Qualanod - Polycarbonate opal 16mm treated anti UV with poly shutter, adhesive microperforated - Floor mounting plate - Fixing screws provided |
|--|---|

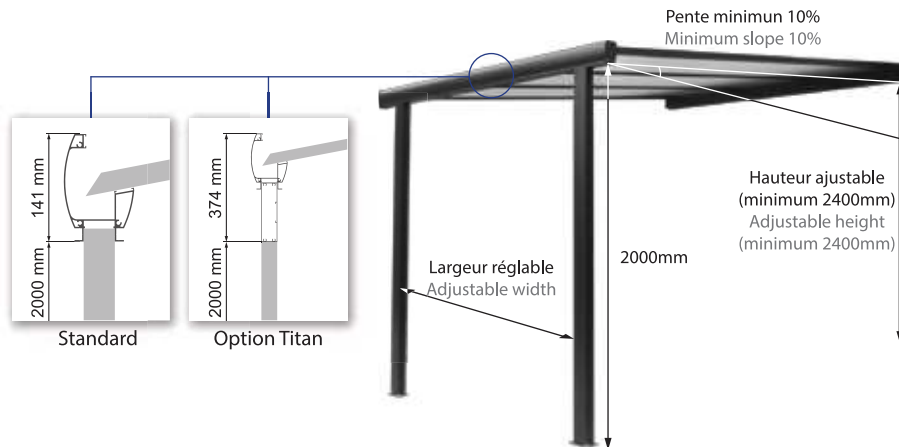
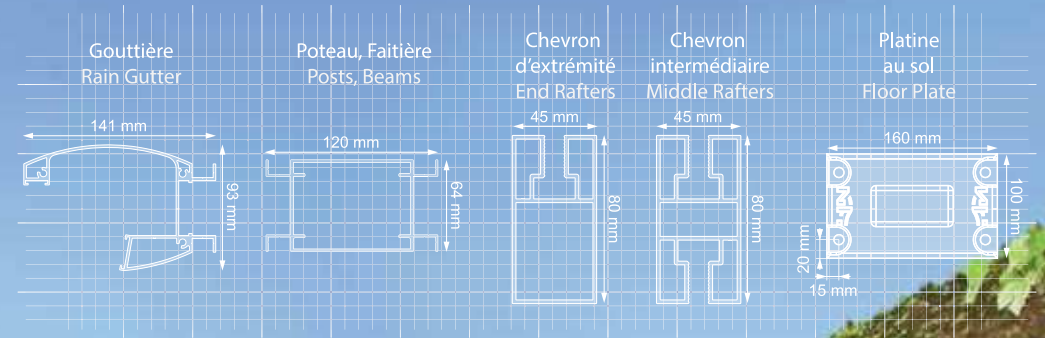

Certifié ENAC - Laboratoire ENSATEC - CE NB 1668 n° de organisme notifié
 Classement - VENT C6
 EN 13561
 Certified ENAC - Laboratory ENSATEC - CE NB 1668 notified entity number
 Ranking - WIND C6
 EN 13561



PERGOLA POLYCARBONATE | PERGOLA POLYCARBONATE SUNVISOR

Caractéristiques | Characteristics:

- | | |
|---|--|
| <ul style="list-style-type: none"> - Possibilité de sur mesure - Poteau et faitière 120x64mm - Gouttière 93x141mm - Chevron 80x45mm - Aluminium thermolaqué Qualicoat / Qualimarine / Qualanod - Polycarbonate opale 16mm traité anti UV avec obturateur poly, adhésif microperforé - Platine de fixation au sol | <ul style="list-style-type: none"> - Custom possibility - Posts and beams 120x64mm - Gutter 93x141mm - Rafters 80x45mm - Powder coated aluminum Qualicoat / Qualimarine / Qualanod - Polycarbonate opal 16mm treated anti UV with poly shutter, adhesive microperforated - Floor mounting plate |
|---|--|

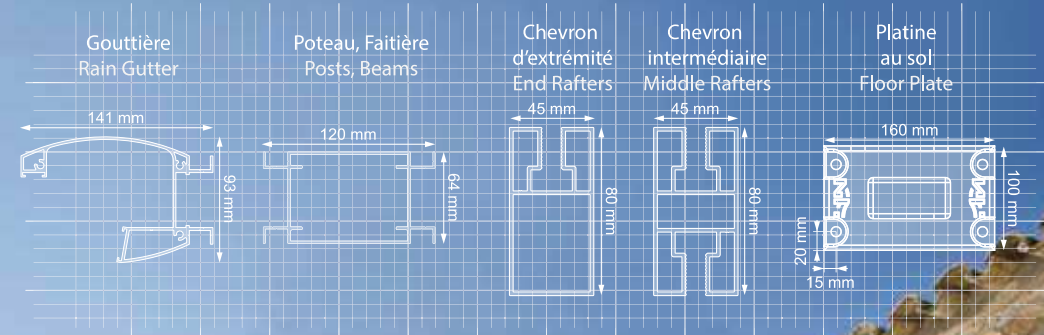
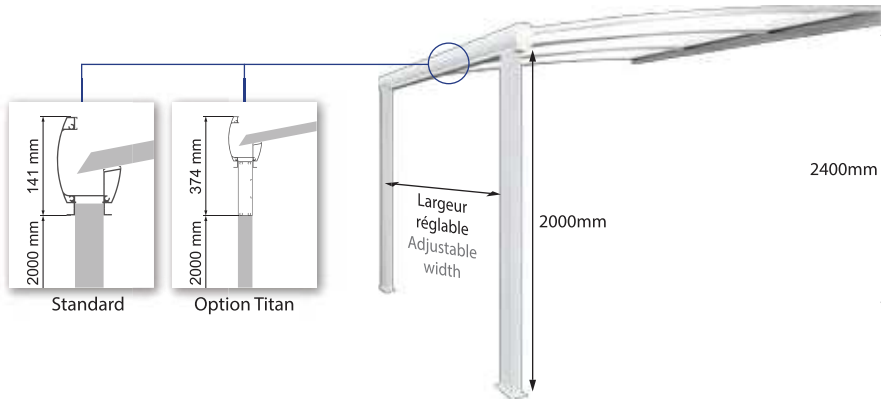

Certifié ENAC - Laboratoire ENSATEC - CE NB 1668 n° de organisme notifié
 Classement - VENT C6
 EN 13561
 Certified ENAC - Laboratory ENSATEC - CE NB 1668 notified entity number
 Ranking - WIND C6
 EN 13561



PERGOLA POLYCARBONATE | PERGOLA POLYCARBONATE

SUNRISE

Caractéristiques | Characteristics:

- | | |
|--|--|
| <ul style="list-style-type: none"> - Existe en adossé et autoportant - Poteau 150x150mm - Poutre gouttière 260x150mm - Chevron 80x45mm - Inclinaison cachée double pente - Aluminium thermolaqué Qualicoat / Qualimarine / Qualanod - Platine de fixation au sol - Panneau de polycarbonate opale 16mm traité anti UV avec obturateur poly, adhésif microperforé | <ul style="list-style-type: none"> - Available as lean to and freestanding - Posts 150x150mm - Gutter beam 260x150mm - Rafters 80x45mm - Hidden double slope - Powder coated aluminum Qualicoat / Qualimarine / Qualanod - Floor mounting plate - Opal polycarbonate panel 16mm treated anti UV with shutter, microperforated adhesive |
|--|--|

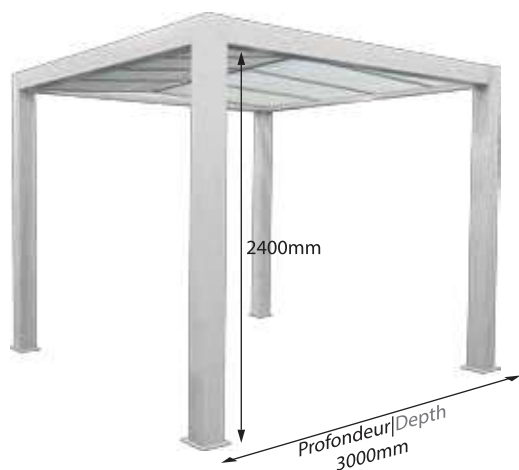

Certifié ENAC - Laboratoire ENSATEC - CE NB 1668 n° de organisme notifié
 Classement - VENT C5
 EN 13561
 Certified ENAC - Laboratory ENSATEC - CE NB 1668 notified entity number
 Ranking - WIND C5
 EN 13561

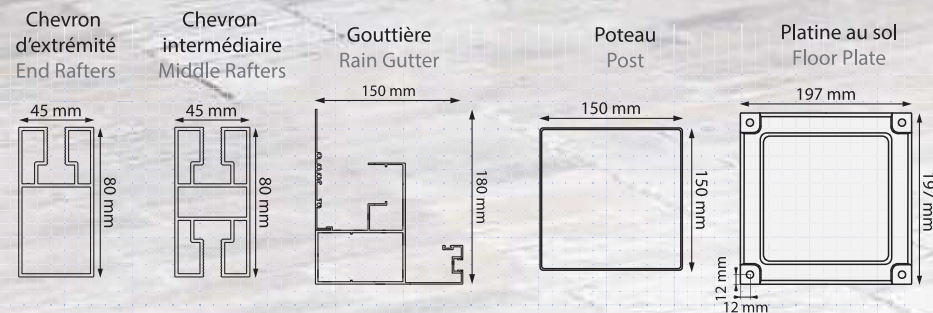
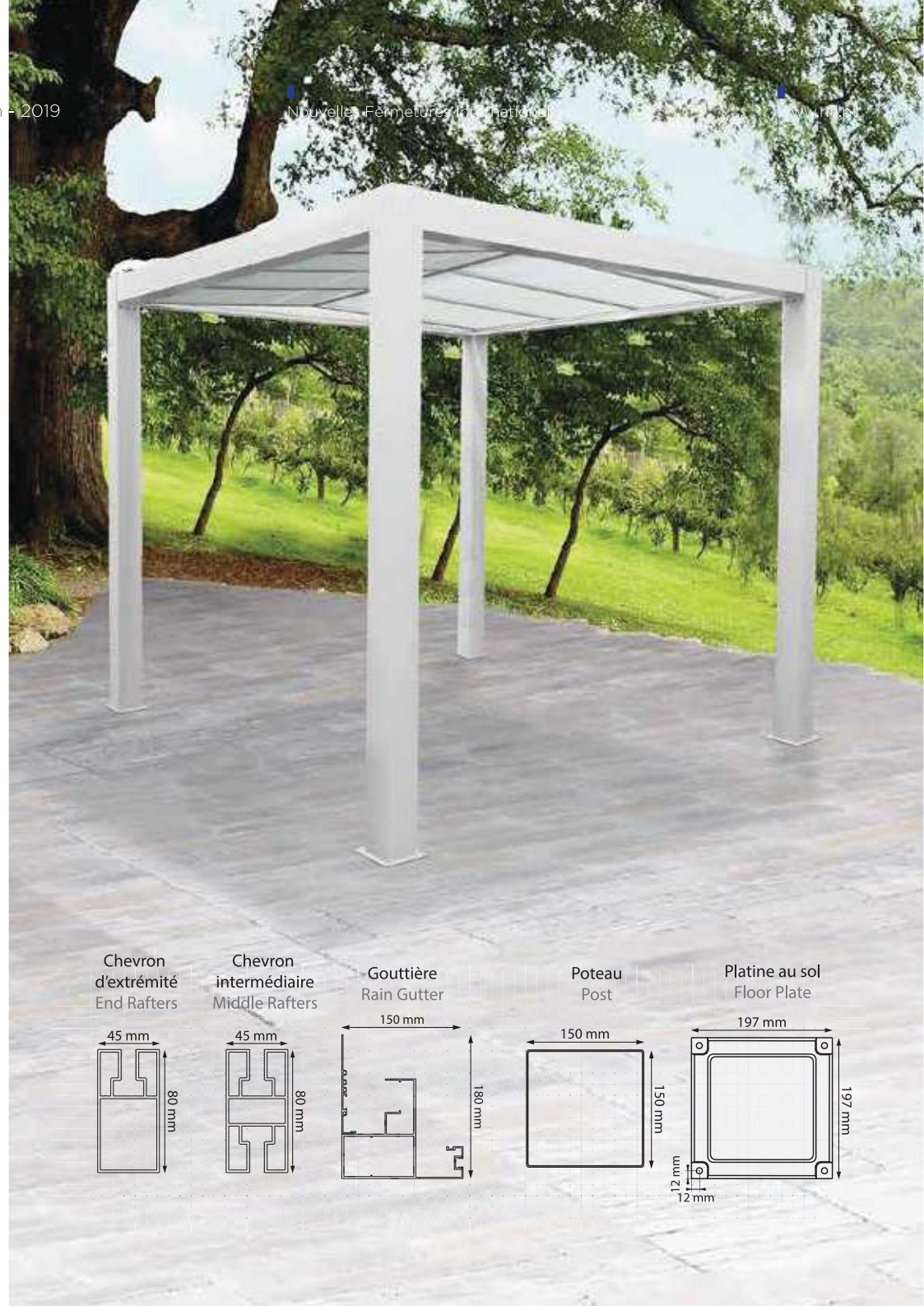

PERGOLA TOILE | PERGOLA SHADE CLOTH

SUNSET

Caractéristiques | Characteristics:

- Sablière 100x100mm
- Poteau 100x100mm pour la option Consensus et Poteau 150x150 pour la option Grandlux
- Aluminium thermolaqué Qualicoat / Qualimarine / Qualanod
- Platine de fixation abs au sol
- Toile polyester 230grs imperméabilisée
- Beams 100x100mm
- Posts with structure 100x100mm with the Consensus option and Posts 150x150mm with the Grandlux option
- Powder coated aluminum Qualicoat / Qualimarine / Qualanod
- ABS floor mounting plate
- Polyester cloth 230grs waterproof

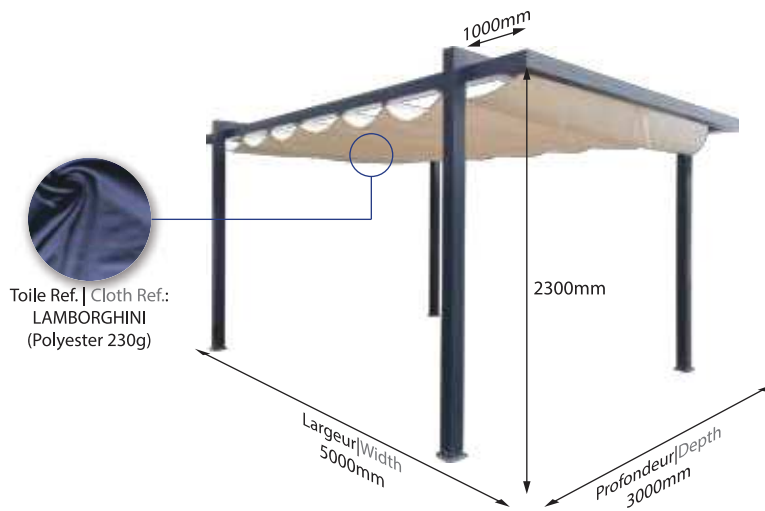

Toile Ref. | Cloth Ref.:
LAMBORGHINI
(Polyester 230g)



Certifié ENAC - Laboratoire ENSATEC - CE NB 1668 n° de organisme notifié
Classement - VENT C2
EN 13561
Certified ENAC - Laboratory ENSATEC - CE NB 1668 notified entity number
Ranking - WIND C2
EN 13561



Consensus:

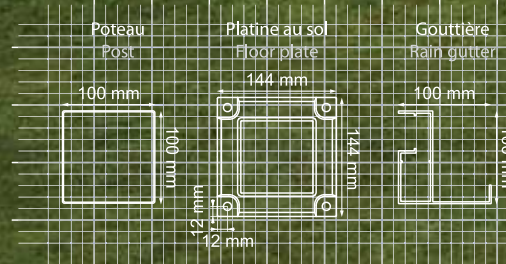

Grandlux:

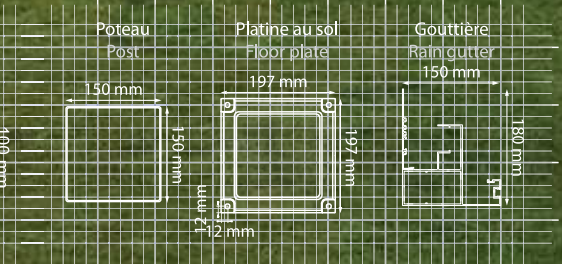

PERGOLA TOILE | PERGOLA SHADE CLOTH SUNSHINE

Caractéristiques | Characteristics:

- Poteau 100x100mm et traverse 60x40mm pour la option Consensus et Poteau 150x150 et traverse 80x40mm pour la option Grandlux
- Aluminium thermolaqué Qualicoat / Qualimarine / Qualanod
- Platine de fixation abs au sol
- Toile polyester 230grs imperméabilisée
- Posts 100x100mm and beams 60x40mm with the Consensus option and Posts 150x150mm and beams 80x40mm with the Grandlux option
- Powder coated aluminum Qualicoat / Qualimarine / Qualanod
- ABS floor mounting plate
- Polyester cloth 230grs waterproof

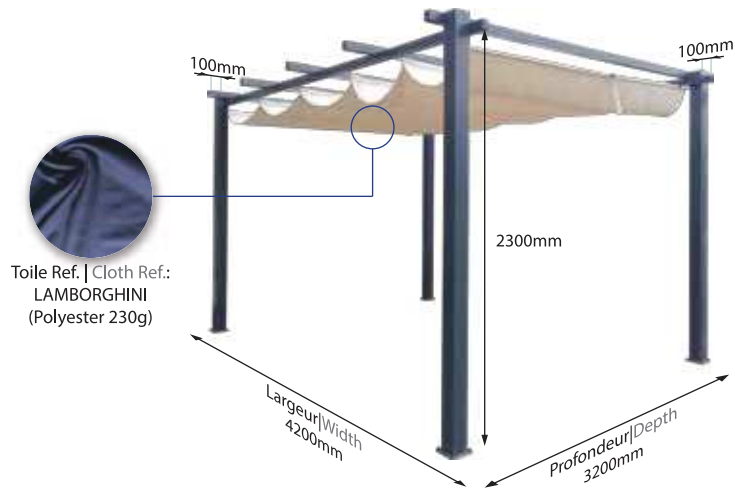

Certifié ENAC - Laboratoire ENSATEC - CE NB 1668 n° de organisme notifié
Classement - VENT C3
EN 13561
Certified ENAC - Laboratory ENSATEC - CE NB 1668 notified entity number
Ranking - WIND C3
EN 13561



Consensus:

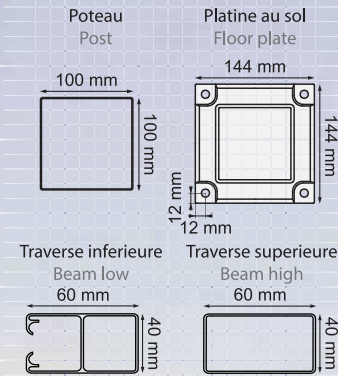

Grandlux:

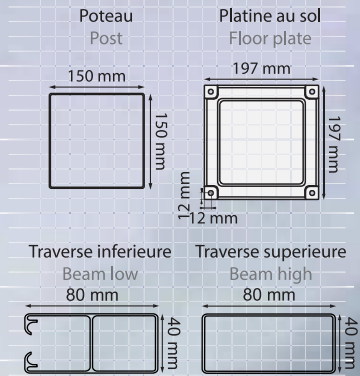

PERGOLA TOILE | PERGOLA SHADE CLOTH SUNLIGHT

Caractéristiques | Characteristics:

- Poteau et gouttière 100x100mm pour la option Consensus and Post and Gutter 100x100mm with the Consensus option
- Poteau et gouttière 150x150mm pour la option Grandlux and Post and Gutter 150x150mm with the Grandlux option
- Aluminium thermolaqué Qualicoat / Qualmarine / Qualanod
- Powder coated aluminum Qualicoat / Qualmarine / Qualanod
- Platine de fixation abs au sol
- ABS floor mounting plate
- Toile polyester 230grs imperméabilisée
- Polyester cloth 230grs waterproof

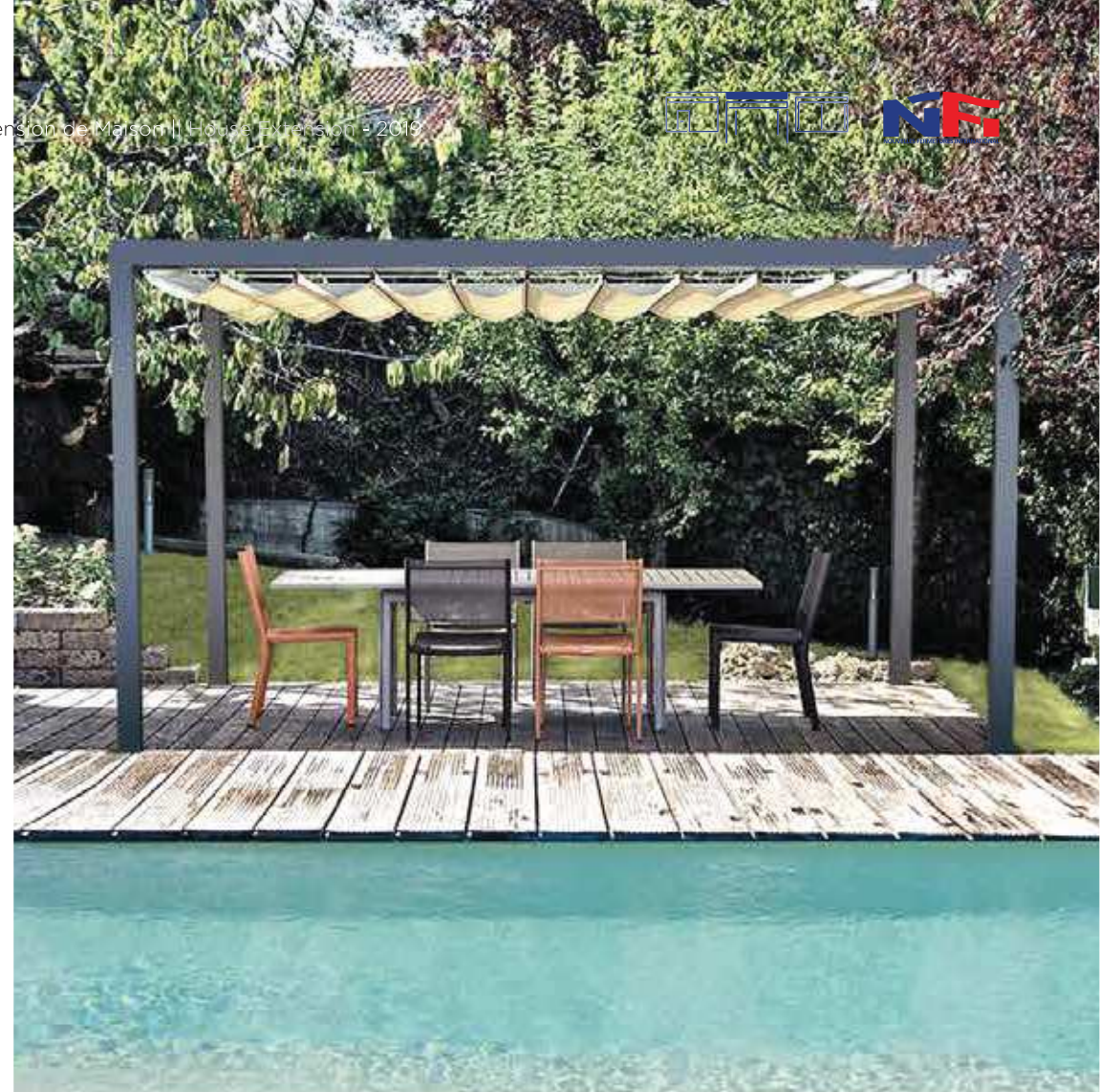
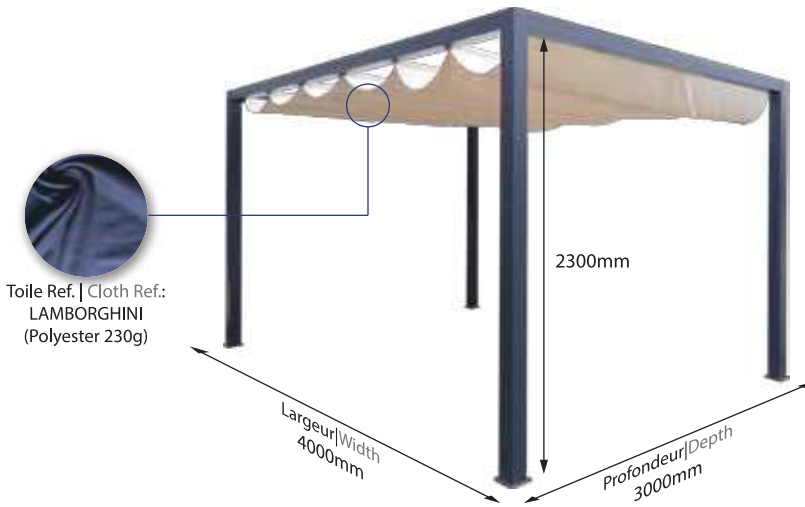

Certifié ENAC - Laboratoire ENSATEC - CE NB 1668 n° de organisme notifié
Classement - VENT C3
EN 13561

Certified ENAC - Laboratory ENSATEC - CE NB 1668 notified entity number
Ranking - WIND C3
EN 13561

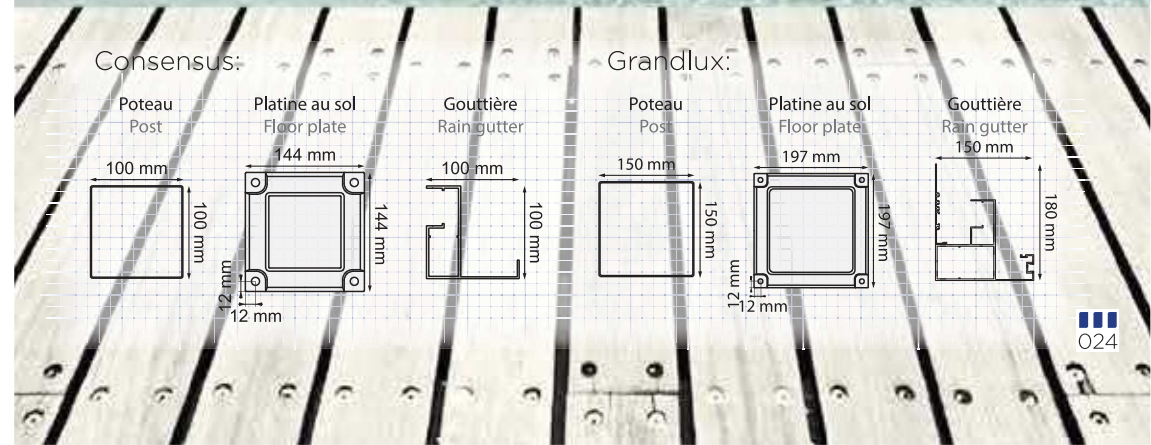

PERGOLA BIOCLIMATIQUE | PERGOLA BIOCLIMATIC

SUNCONTROL II

Caractéristiques | Characteristics:

- Existe en adossé et autoportant
- Poteau 150x150mm
- Poutre gouttière 150x260mm
- Lame 200mm double parois
- Automatisation à vis sans fin caché
- Aluminium thermolaqué Qualicoat / Qualmarine / Qualanod
- Platine de fixation au sol
- Led intégrées en périphérie
- Boîtier de commande invisible avec télécommande et Application mobile (Android)

- Available as lean to and freestanding
- Posts 150x150mm
- Gutter beam 150x260mm
- Double walled slats 200mm
- Hidden worm-screw automation
- Powder coated aluminum Qualicoat / Qualmarine / Qualanod
- Floor mounting plate
- Peripheral build-in LEDs
- Invisible control box controled by remote control and smartphone app (Android)

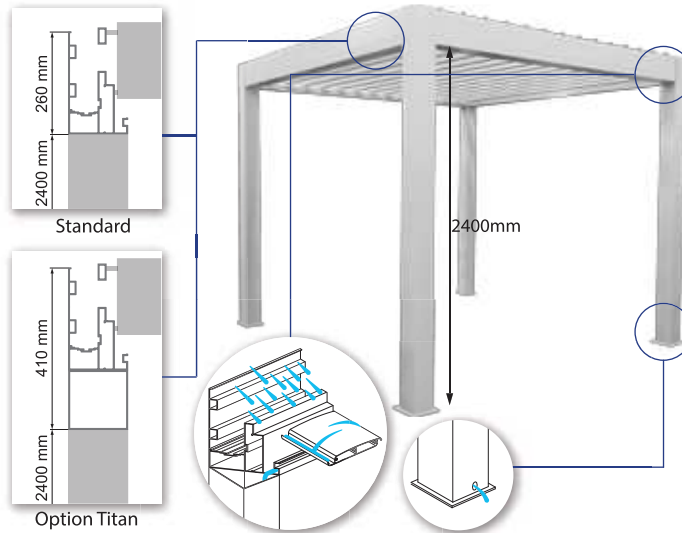

Seulement pour pergola de deux modules avec lames perpendiculaires
Only for Pergola with two modules with perpendicular slats

8	9	10	11	12	13	14	15	16	17	18	19	20	21	22	23	24	22	23	24	25	26	27	28	29	30	31	32	33	34	35	36	37	38	39	40	41	42	43	44
1120	2017	2214	2411	2608	2805	3002	3199	3396	3593	3790	3987	4184	4381	4578	4775	4972	4654	4851	5048	5245	5442	5639	5836	6033	6230	6427	6624	6821	7018	7215	7412	7609	7806	8003	8200	8397	8594	8791	8988

Option TITAN				
25	26	27	28	29
5169	5366	5563	5760	5957



Certifié ENAC - Laboratoire ENSATEC - CE NB 1668 n° de organisme notifié
Classement - VENT C5
EN 13561
Certified ENAC - Laboratory ENSATEC - CE NB 1668 notified entity number
Ranking - WIND C5
EN 13561

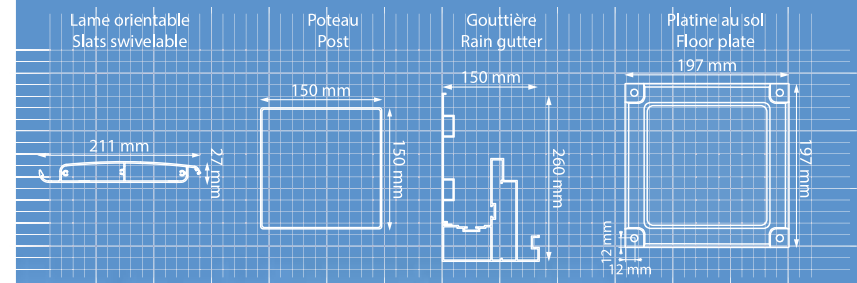

PERGOLA BIOCLIMATIQUE | PERGOLA BIOCLIMATIC

SUNNYCONTROL II

Caractéristiques | Characteristics:

- Existe en adossé et autoportant
- Poteau 100x100mm
- Poutre gouttière 100x100mm
- Aluminium thermolaqué Qualicoat / Qualimarine / Qualanod
- Lame simple parois 200mm
- Automatisation à vis sans fin
- Platine de fixation au sol
- Vis de fixation fournies
- Boîtier de commande invisible avec télécommande et Application mobile (Android)

- Available as lean to and freestanding
- Posts 100x100mm
- Gutter beam 100x100mm
- Powder coated aluminum Qualicoat / Qualimarine / Qualanod
- Single walled slats 200mm
- Worm-screw automation
- Floor mounting plate
- Fixing screws provided
- Invisible control box controlled by remote control and smartphone app (Android)

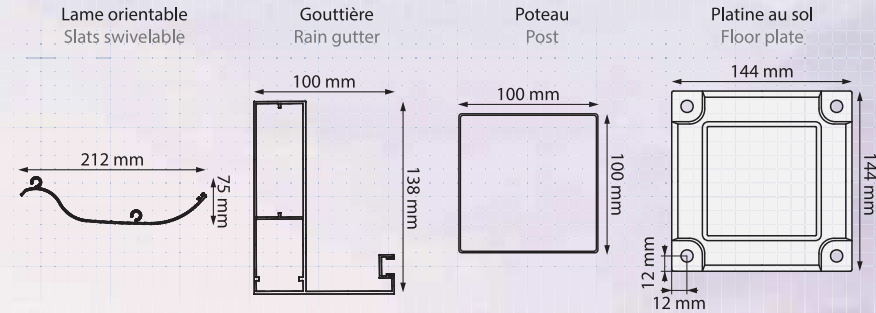
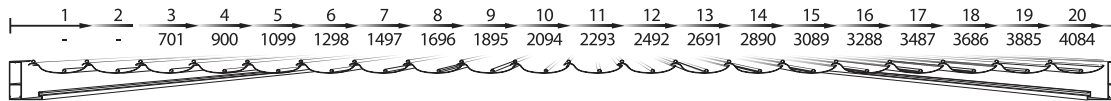
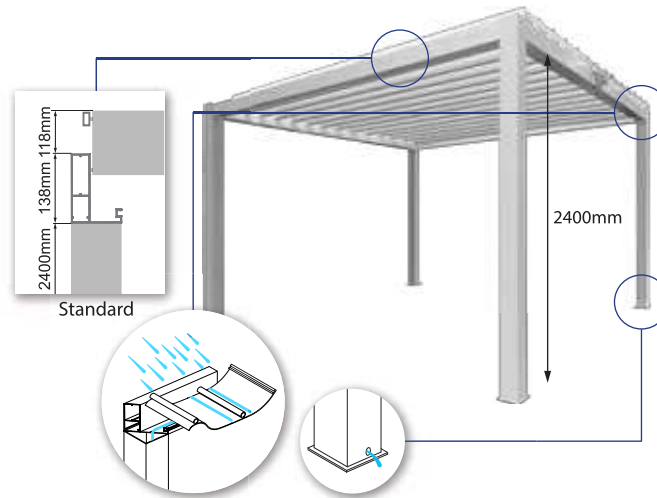

Certifié ENAC - Laboratoire ENSATEC - CE NB 1668 n° de organisme notifié
 Classement - VENT C5
 EN 13561
 Certified ENAC - Laboratory ENSATEC - CE NB 1668 notified entity number
 Ranking - WIND C5
 EN 13561

